

# KELVIN

12V BSP00026AC12 / 24V BSP00026AC24



# Bergstrom

STANDARD PRODUCTS

A/C



### Performance

<b>cold</b> ❄️ 20,810 BTU/hr	+	<b>airflow</b> 🌀 460 SCFM
------------------------------------	---	---------------------------------

### Electrical Data

volts	amps	/	volts	amps
12V	21.6A		24V	11A

### Applications



### Performance Input Data

<b>temperature</b> 100°F	<b>humidity</b> 40%
-----------------------------	------------------------

## Horizontal Evaporator Unit

### Position

Multiple mount

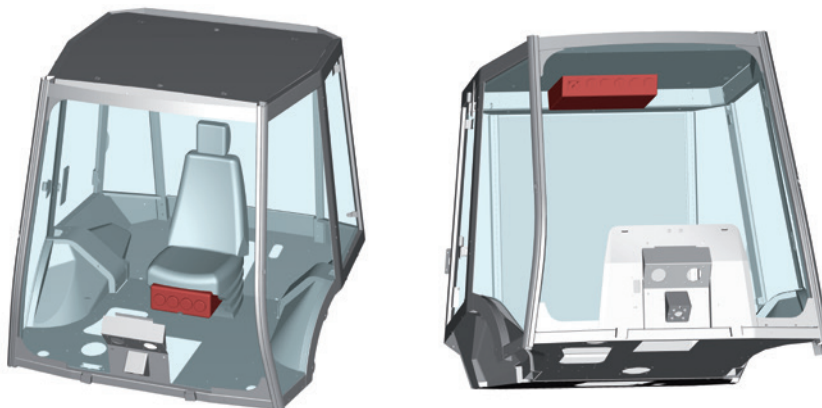



# Bergstrom

STANDARD PRODUCTS

## KELVIN

12V BSP00026AC12 / 24V BSP00026AC24

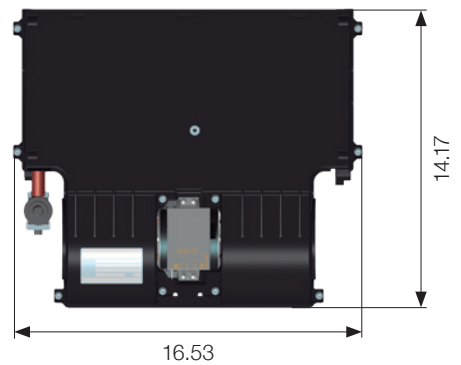
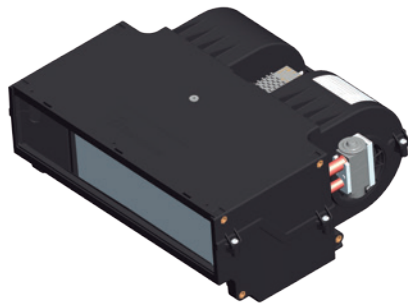
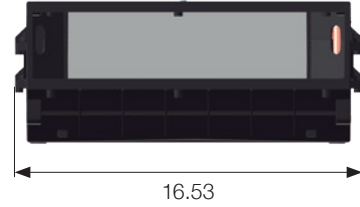
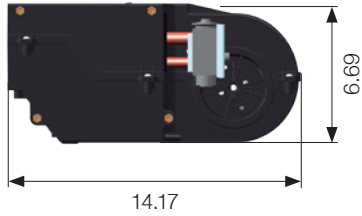

Weight

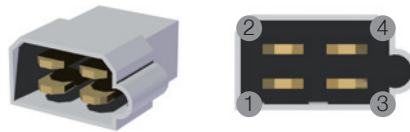
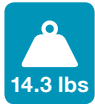

- 1 - Yellow wire (speed 1)
- 2 - Red wire (speed 2)
- 3 - Orange wire (speed 3)
- 4 - Black wire (ground)

Hose 1/2"  
7/8-14UNF

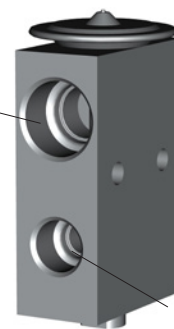

Hose 5/16"  
5/8-18UNF

Expansion valve 2.0 TON

To ensure you have a complete kit to enable your chosen system to operate please check the system schematic data sheet which details the full list of components required.

T // 1.800.499.6849

E // enquiries@bergstromstandardproducts.com

W // www.bergstromstandardproducts.com



Outlet panels - Kelvin evaporators

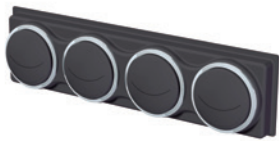

Kit - Outlet panel for Kelvin evaporator  
Black vents / Frame - chrome  
15.19x3.87x1.18 (4x Ø3.01)  
**Cod.: BSP00002PANELKIT**

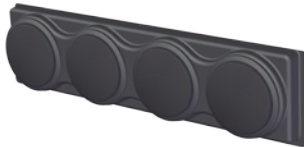
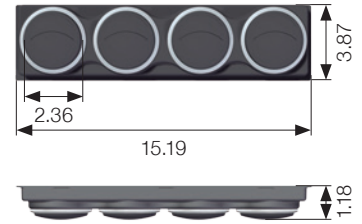

Kit - Outlet panel for Kelvin evaporator  
Black vents / Frame - black  
15.19x3.87x1.18 (4x Ø3.01)  
**Cod.: BSP00004PANELKIT**

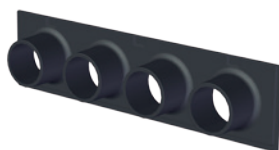
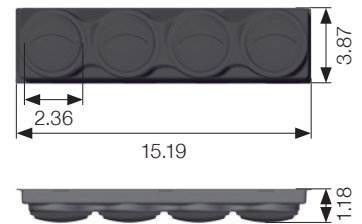

Kit - Outlet panel for Kelvin evaporator  
Black  
15.19x3.85x1.96 (4x Ø2.36)  
**Cod.: BSP00001PANELKIT**

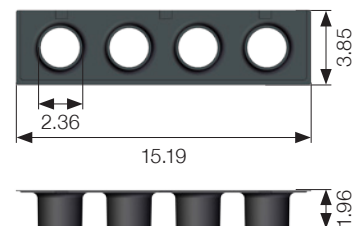



### Bracket kits - Kelvin evaporators



Bracket Kit  
Mount to the floor or roof  
**Cod.: BSP00003MOUNTKIT**

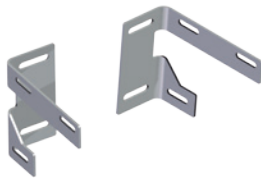

Bracket Kit  
Mount to the bulkhead or wall  
**Cod.: BSP00005MOUNTKIT**

### Drain hose kits - Kelvin evaporators



Kit - Drain hose  
(1 side)  
**Cod.: BSP00001DRAINKIT**



Kit - Drain hose  
(2 side)  
**Cod.: BSP00002DRAINKIT**

*To ensure you have a complete kit to enable you chosen system to operate please check the system schematic data sheet which details the full list of components required.*