

BIDIRECCIONAL

12V BSP00023AC12 / 24V BSP00023AC24



Bergstrom

STANDARD PRODUCTS

A/A

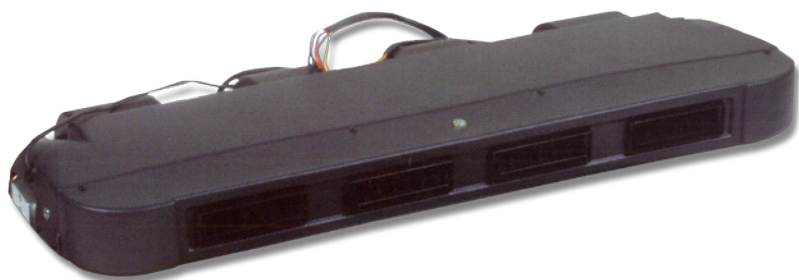

Rendimiento

frío	+	caudal
8,7kW		820 (m³/hr)

Datos eléctricos

voltaje	consumo	/	voltaje	consumo
12V	30A		24V	15A

Aplicaciones



Datos de entrada de rendimiento

temperatura	humedad
32°C	50%

Unidad Evaporadora

Posición

Montaje bajo techo

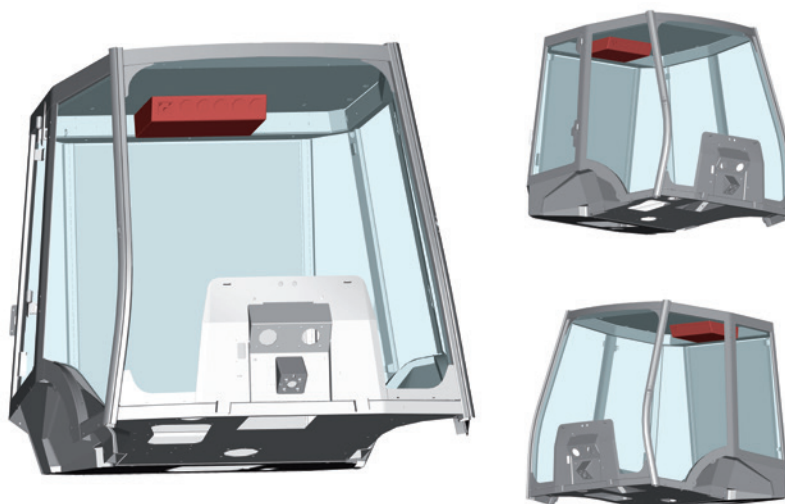



Bergstrom
STANDARD PRODUCTS

BIDIRECCIONAL

12V BSP00023AC12 / 24V BSP00023AC24

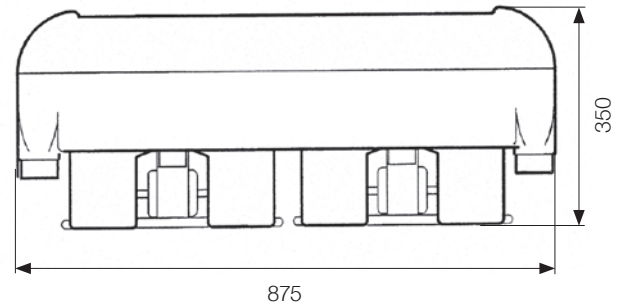
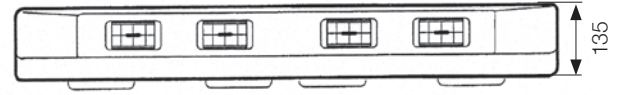
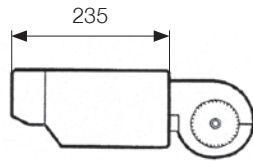

Peso

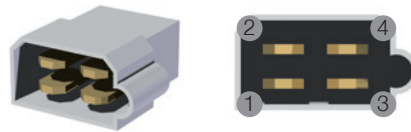

- 1 - Cable amarillo (velocidad 1)
- 2 - Cable rojo (velocidad 2)
- 3 - Cable naranja (velocidad 3)
- 4 - Cable negro (tierra)

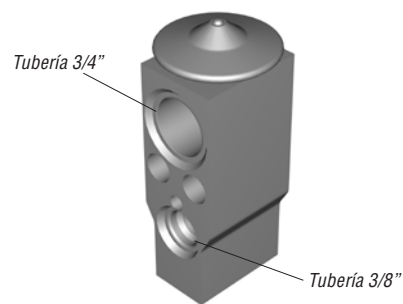

Válvula de expansión 1.5 TON
(5275 Kcal/h)

Para asegurarse que Usted tiene un equipo de A/C funcional con el componente elegido, por favor revise la hoja de esquema de sistemas de A/C con la lista completa de los componentes necesarios.

T // (+34) 91 877 58 40

E // consultas@bergstromstandardproducts.com

W // es.bergstromstandardproducts.com